



COMPLIES WITH REQUIREMENTS OF

- * IEC STANDARDS 947-4-1 AND 947-5-1 LOW VOLTAGE DIRECTIVE
- * IEC = INTERNATIONAL ELECTROTECHNICAL COMMISSION
- * CE TESTING AND EVALUATION PERFORMED BY THE UNDERWRITERS LABORATORIES AS A THIRD PARTY PARTICIPANT



RECOMMENDED CHASSIS CUTOUT BOTTOM VIEW

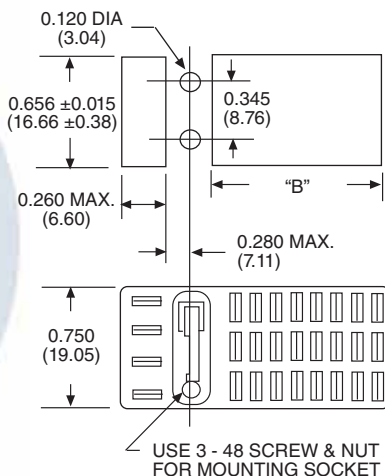

OUTLINE DIMENSIONS
DIMENSIONS SHOWN IN INCHES & (MILLIMETERS).
TOLERANCES: ± 0.010 (± 0.25)
UNLESS OTHERWISE SHOWN

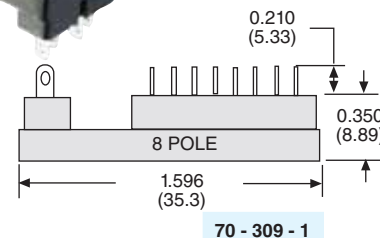
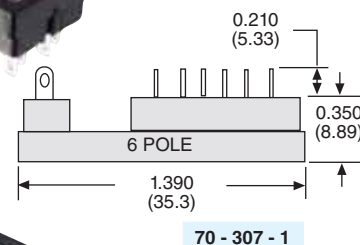
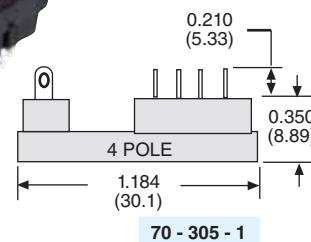
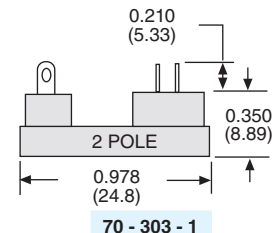

CHASSIS CUTOUT

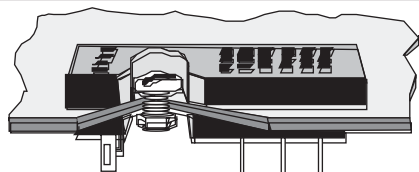

CHASSIS CUTOUT DIMENSION "B"

SPDT DPDT	4PDT	6PDT	8PDT
0.343 (8.71)	0.562 (14.27)	0.781 (19.84)	1.00 (25.4)

GENERAL SPECIFICATIONS (@ 25°C)

	UNITS	
NUMBER OF TERMINALS		8, 14 or 20
ELECTRICAL RATING		
Nominal Voltage Rating:	Volts	300
Nominal Current Rating:	Amps	10
DIELECTRIC STRENGTH		
Output to Adjacent output Terminals:	V rms	1000
Output to Input Terminals:	V rms	1000
Terminals to Rail Chassis:	V rms	1000
CONSTRUCTION		
Protection Category (Finger Safe):	IEC	N / A
Internal Metal Tracks:		Copper Alloy, Zinc Plated
TEMPERATURE		
Operating, Lower:	°C	-40
Operating, Upper:	°C	+80
MISCELLANEOUS		
Chassis Mount Screw Torque:	Lb-in / Nm	N / A
Flammability Rating:		
Wire Size:	AWG/mm ²	20 - 18 / 0.5 - 0.8
Body Color:		Black
Weight:	grams	4.3 - 6.9

Mating Relay
67

See section 1

Mating Hold Down Clips

(70-303-1) 16-875-1

(70-305-1) 16-875-2

(70-307-1) 16-875-3

(70-309-1) 16-1120-8

HOLD DOWN CLIPS ARE INCLUDED

STANDARD PART NUMBER	DESCRIPTION
70 - 303 - 1	2 POLE SOLDER TERMINALS
70 - 305 - 1	4 POLE SOLDER TERMINALS
70 - 307 - 1	6 POLE SOLDER TERMINALS
70 - 309 - 1	8 POLE SOLDER TERMINALS



COMPLIES WITH REQUIREMENTS OF

- * IEC STANDARDS 947-4-1 AND 947-5-1 LOW VOLTAGE DIRECTIVE
- * IEC = INTERNATIONAL ELECTROTECHNICAL COMMISSION
- * CE TESTING AND EVALUATION PERFORMED BY THE UNDERWRITERS LABORATORIES AS A THIRD PARTY PARTICIPANT

RECOMMENDED PRINTED CIRCUIT LAYOUT TOP VIEW

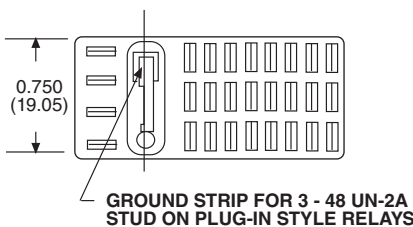
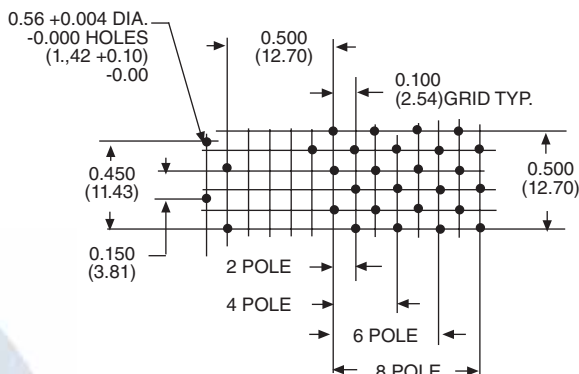

NOTE:
WHEN INSTALLING SOCKET(S) INTO A PRINTED CIRCUIT BOARD, USE PLUG-IN STYLE RELAYS FOR MAXIMUM TERMINAL CONTACT WITH MATING SOCKET. PLUG-IN STYLE RELAYS HAVE A GROUNDING STUD AND ARE RECOMMENDED FOR USE WITH ALL SOCKET STYLES.

OUTLINE DIMENSIONS

DIMENSIONS SHOWN IN INCHES & (MILLIMETERS).
TOLERANCES: ± 0.010 (± 0.25)
UNLESS OTHERWISE SHOWN

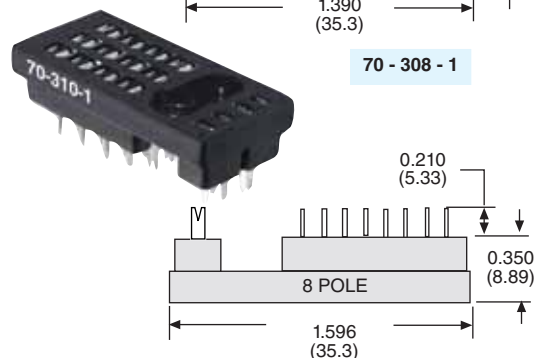
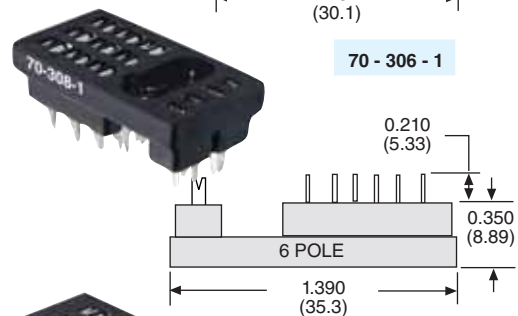
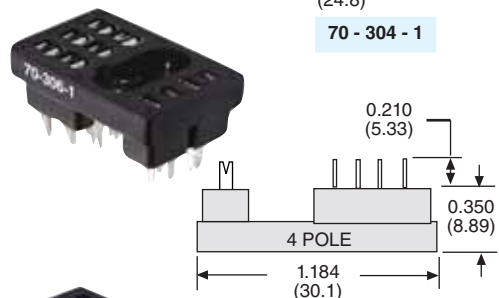
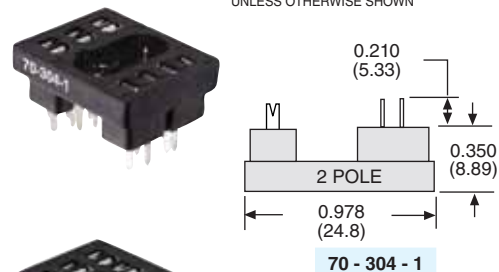

HOLD DOWN CLIPS ARE INCLUDED

Mating Relay
67

See section 1

Mating Hold Down Clips

(70-304-1) 16-875-1

(70-306-1) 16-875-2

(70-308-1) 16-875-3

(70-310-1) 16-1120-8

GENERAL SPECIFICATIONS (@ 25°C)

	UNITS	
NUMBER OF TERMINALS		8, 14 or 20
ELECTRICAL RATING		
Nominal Voltage Rating:	Volts	300
Nominal Current Rating:	Amps	10
DIELECTRIC STRENGTH		
Output to Adjacent output Terminals:	V rms	1000
Output to Input Terminals:	V rms	1000
Terminals to Rail Chassis:	V rms	1000
CONSTRUCTION		
Protection Category (Finger Safe):	IEC	N / A
Internal Metal Tracks:		Copper Alloy, Zinc Plated
TEMPERATURE		
Operating, Lower:	°C	-40
Operating, Upper:	°C	+80
MISCELLANEOUS		
Chassis Mount Screw Torque:	Lb-in / Nm	N / A
Flammability Rating:		
Wire Size:	AWG/mm ²	N / A
Body Color:		Black
Weight:	grams	4.3 - 6.9

STANDARD PART NUMBER	DESCRIPTION
70 - 304 - 1	2 POLE PRINTED CIRCUIT TERMINALS
70 - 306 - 1	4 POLE PRINTED CIRCUIT TERMINALS
70 - 308 - 1	6 POLE PRINTED CIRCUIT TERMINALS
70 - 310 - 1	8 POLE PRINTED CIRCUIT TERMINALS